

torres de iluminación
mât d'éclairage
lighting towers



Apolo 80000



HIMOINSA[®]



INDEX

INTRODUCTION	3
1. SAFETY REGULATIONS	4
2. COMPOSITION AND LOCATION OF ITS COMPONENTS	9
2.1. COMPOSITION	9
2.3. LOCATION OF ITS COMPONENTS	10
3. START UP	13
3.1. LEVELS	13
3.2. ANCHORAGE	13
3.3. INSTALLING THE SPOTLIGHTS	15
3.4. CONNECTING THE GENSET TO TOWER	16
3.5. STARTING UP THE GENSET	16
3.6. STARTING THE ELECTRICAL MOTOR	16
3.7. MAST OPERATION AND SPOTLIGHTS ORIENTATION	17
3.8. WORKING SAFETY POSITION	20



3.9. SWITCHING THE SPOTLIGHTS	19
4. OPERATIONS TO CARRY OUT AFTER USE	20
4.1 SWITCHING OFF THE SPOTLIGHTS	20
4.2. FOLDING THE MAST	20
4.3. MAIN SWICHT DISCONNECTION	20
4.4. STOPPING GENSET	20
4.5. DISCONNECTING THE GENERATING SET TOWER	20
4.6. DISCONNECTING THE SPOTLIGHTS	20
4.7. FOLDING OF THE TELESCOPIC SPLINDE BEARINGS	20
5. LIGHTING TOWER MAINTENANCE	21
6. FAILURES	21
7. GUARANTEE CONDITIONS	22



INTRODUCTION

By means of this handbook we intend to provide the basic instructions and information for a proper installation, use and maintenance of the HIMOINSA Lighting Tower.

All activities to do with the internal functioning of the tower and the generating set that compose it, must be carried out by specialized personnel, with experience in Diesel engines and mechanical installations as well as in generation of electricity. This handbook and all the other reference documentation are indispensable in order to prepare these specialists.

At Himoinsa we think of you, that's why its essential that you thoroughly read all safety regulations and warnings before you start the lighting tower, only by doing this we can assure you an optimal service in perfect reliability and safety conditions.

HIMOINSA advises that the validity of the information in this handbook refers to the date that it was issued, as several aspects such as the technological developments, new regulations or updates and improvements of the models oblige us to make changes without notice, which may not appear in the current manual.

This Handbook and the rest of the reference documentation, form part of the lighting tower that you have purchased and must be kept and protected against any agent that may damage them. This documentation must accompany the equipment whenever it is leased to any other user or new owner. Although all the information in this handbook has been thoroughly verified, HIMOINSA refuses any responsibility for any spelling typographic or transcription errors.

In accordance with Directive CEE 85/374 and subsequent modification 99/34, HIMOINSA will not be deemed responsible due to defective installations, improper uses of the machine and non fulfilment of the regulations of this manual.



1. SAFETY REGULATIONS

Before working on the machine carefully read the following safety regulations, and find out about the local requirements in safety.

The installation, operation, maintenance and repairs must be carried out only authorized and competent personnel.

The owner is responsible for the maintenance of the Lighting Tower in good safety conditions. The parts and accessories must be replaced if they are not in good functioning conditions.

1.1. General safety precautions.

- Do not allow non-authorized people to be close to the Lighting Tower.
- Do not allow people with pacemakers to get close to the tower as it may cause electromagnetic interferences on these devices.
- Do not get close to the Tower wearing loose clothes or objects that may be attracted by the airflow or by the mobile parts of the engine.
- It is forbidden to dismount or disable any safety device.
- It is forbidden to lean on the Lighting Tower or leave objects on it.



If the Lighting Tower is driven by automatic driving sets, it is necessary to:

- Place a red light that switches on when the unit is working, in a visible place.
- Place a warning sign warning of the possibility that and automatic unexpected start up of the machine may occur.
- Place an obligations sign stating: "All maintenance operations must be carried out with the genset in the LOCK position".
- For the emergency stop of the group, press "emergency stop" push button, located in the group or the emergency push button to be installed outside the engine room.

1.2. Safety at delivery, storage and unpacking.

- Once you receive the lighting tower check that the goods received correspond to those on the delivery note and that all the goods are in perfect conditions.
- To lift and transport the Tower, lifting machines the appropriate capacity must be used. All loose and pivoting parts must be safely fixed before lifting it.
- When moving the lighting Tower and specially when lifting it , it is recommended to use the available points for its safe and easy movement.



- It is totally forbidden to use any other lifting points located over the engine, alternator or other components.
- If the lighting Tower is damaged for any reason during its transportation, storage, and/or mounting, it mustn't be started up before it is verified by our specialized personnel.
- If you want to store the Tower until its utilization, it is highly recommendable to have a warehouse properly protected against any chemical agent that may damage its components.
- Unpacking must be carried out carefully, avoid causing any damages to the goods during such operation, especially when using levers, saws or any other metallic tools.

WARNINGS:

Do not place the mast in vertical position, before opening the levelling feet or before stabilizing the mast over a firm and regular surface. The Tower could overturn causing serious physical and / or material damages.

Once the pole is totally opened, verify the following points:

- The mast must be totally perpendicular to the ground.
- The feet must be in touch with the ground.
- All fixings must be locked.
- Do not move the tower when the flood lights are on. The high temperatures that the filaments of the lights reach, make them very vulnerable to small vibrations, therefore we recommend switching off the floodlights 10 minutes before moving the equipment.



- Do not fold the mast of the unit without having lowered it.
- Do not open the pressure control valve at the bottom of the mast when it is opened.

1.3. Safety during installation and first start up.

- For provisional installations, it will just be enough to place the unit on a well levelled surface, for installations for a longer period of time, its advisable to build foundations. The installation of the Generating set and all its accessories must be carried out by specialized personnel. If any difficulty, consult the Himoinsa Technical Department.
- You must know all the emergency procedures related to the installation to be done.
- Always use a protective hard hat, safety boots and gloves, safety goggles and tight clothes.
- Do not change the original protections, located on the rotary exposed parts, over the hot surfaces, air intakes, belts and parts in tension.
- Do not leave dismounted parts, tools or any other accessory on top of the engine or nearby or at the premises of the genset.
- Never leave flammable liquids or cloths soaked with flammable liquids near the generating set, near electrical devices or parts of the electrical installation (including lamps).
- Take all precautions possible in order to avoid flare risks; check that there is a grounds installation and that has been made according to Regulations.



- Place a sign “No Manoeuvring” in all the sectioning organs that insulate the parts of the installation on which you must work.
- Insulate all disconnected links and wires. Do not leave uncovered the voltage terminals of the generator.
- Connect the grounds installation to all the connexion relative points prepared in the unit and its accessories.
- Verify and check that the voltage connections as well as the auxiliary services have been made properly.
- When installing the battery, first connect the positive terminal and after the negative one. Negative pole to the engine block.
- Check the cyclical direction of the phases is according to the mains.
- Individualize the position of the emergency stop button pushers, the quick fuel interception valves, the switches and any other emergency systems present in the installation.
- Isolate all the connections and disconnected threads. Don't leave open the terminals of power of the generator



2. LIGHTING TOWER: COMPOSITION AND LOCATION OF ITS COMPONENTS.

2.1. COMPOSITION.

The lighting towers of Himoina are composed basically of:

- Elevation kit.
- Genset.
- Mobile kit.

	L	W	H	Weight
minimum	3.700	1.570	2.100	970
maximum	4.000	3.100	8.900	970

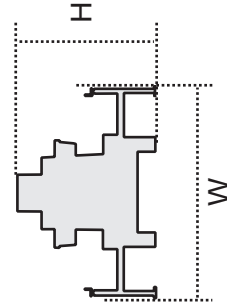
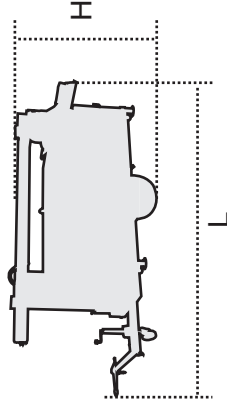
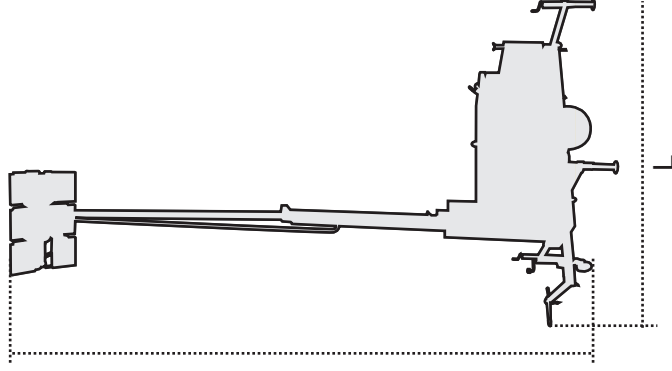

2.2. LOCATION OF ITS COMPONENTS.

TELESCOPIC MAST.

Consisting of 3 expansions made in extruded aluminium T6 and anodized with a 15 microns layer.

SUPPORT FOR SIX PROJECTORS.

Made of quartz iodine with 1.500 watts power and a flow of 33.100 lumens each.

MAST SUPPORT.

Among other functions, houses and protects the electrical motor that drives all the hydraulic system of the mast.

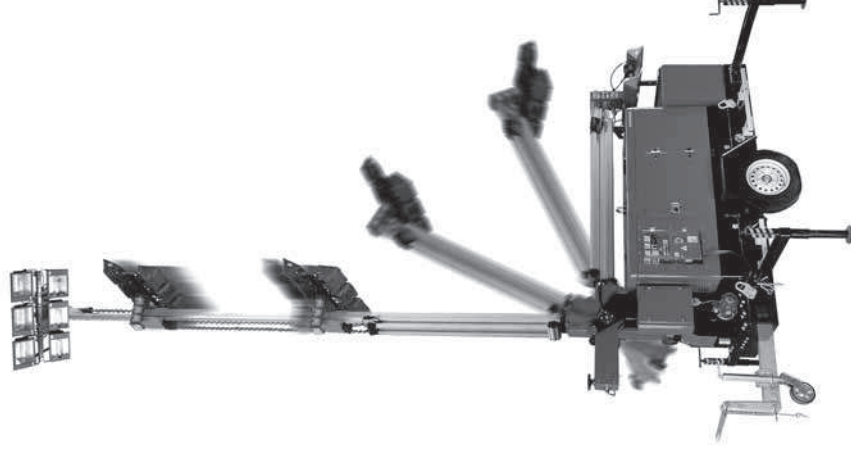



WATERPROOF CONTROL AND MANEUVERING SHELTER. (1)

Houses and protects in its interior the mast control automatic central, the maneuvering panel and the generator set- tower connection hose.

REAR CABINET. (2)

With manual lock with key and foam protection, designed in order to keep the 6 projectors during transportation.

1



2





MOBILE KIT.

Composed of a rigid shaft, articulated nozzle (optional) (1), hooking on eye (2), hiding jockey wheel (3), 4 extensible legs protected with nylon in all their surface (4), on the chassis it has 4 lifting eyes clearly indicated (5).

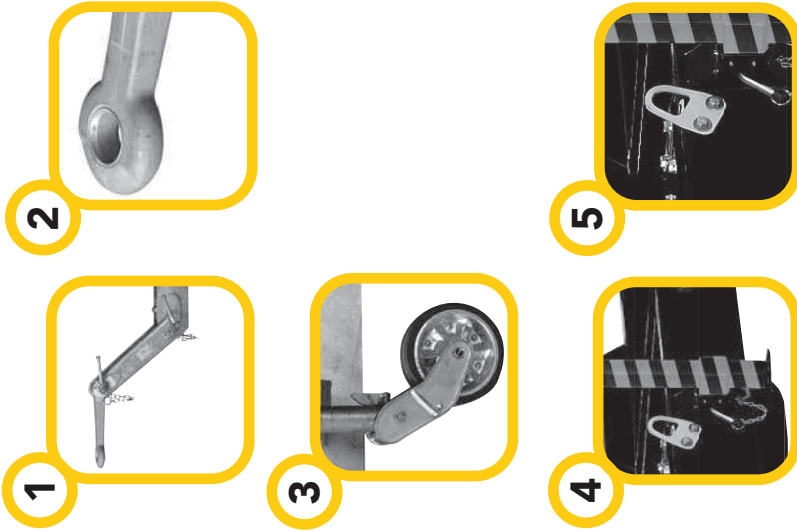



3. START UP.

3.1. LEVELS.

Check all levels of the equipment.

Hydraulic oil level, it can be checked by looking at the indicator that is on the front side of the oil tank (under the motor). It must be done when the tower is resting and it has to be at least $\frac{3}{4}$ of the total.(1)

For water, oil and gas oil levels see generating set manual.

3.2. ANCHORAGE.

As described in the safety chapter, do not raise the mast before opening the levelling feet and stabilizing the tower on a firm and regular surface, in order to do so, follow the steps bellow:

- Take out the safety brackets of the pins. (2)
- Pull out the pins vertically. (2)

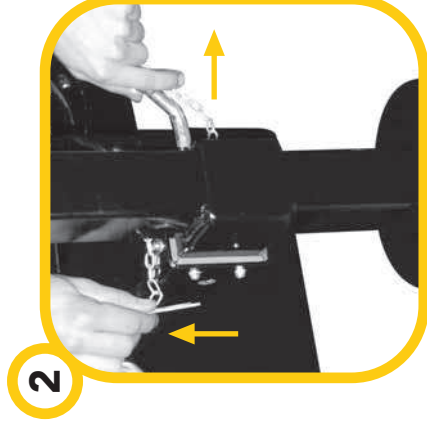
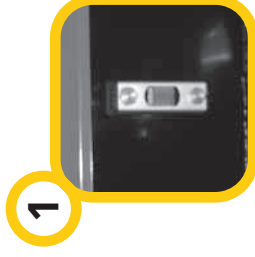



- Extract the legs (3).
- Put the safety brackets back in again (3).
- Turn the uppermost handle on the telescopic spindle bearings until it grips there is a certain resistance. In this way one can balance and fix the tower to the chosen work surface (4).

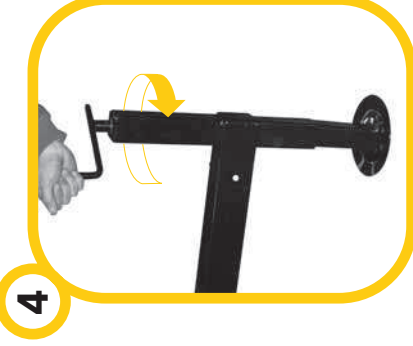
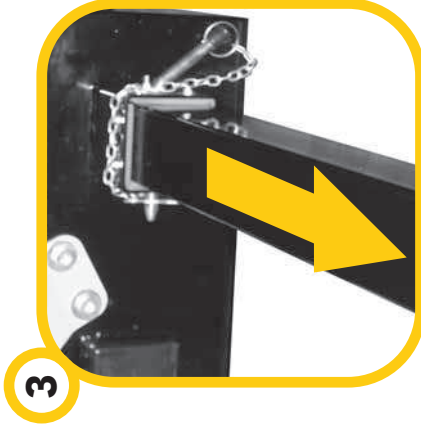



3.3. INSTALLING THE SPOTLIGHTS.

Place the supplied spotlights in their corresponding slots, fixing them with the wingnuts located at the end of the mast.

In order to carry out this operation, unscrew the wingnut and remove the supporting bracket (1). Fit the spotlights (2) (with the glass upwards), place the supporting bracket which grips the spotlight mounting, then the wingnut and tighten it firmly (3).

Once all spotlights are in place connect each one to its corresponding socket (4).

1



2



4

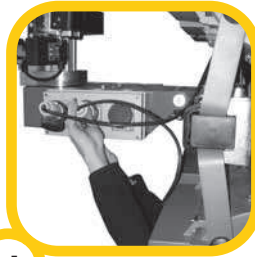

3

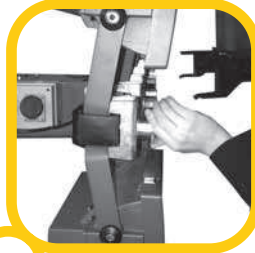



3.4. CONNECTING THE GENERATING SET TO TOWER.

Once you have verified the connexion and the proper fixing of the spotlights, we will connect the generating set to the lighting tower.

In order to carry out this operation, get the extension cable that is in one of the side compartments (1), and connect one of the ends to the corresponding power output located in the generating set (2) control panel and the other end to the lighting tower (3).



3.5. STARTING UP THE GENERATING SET.

As shown in the start up procedure described in the instructions of the generating set.

3.6. STARTING THE ELECTRICAL MOTOR.

In order to raise the mast you must connect the main switch at the tower control panel (panel located in one of the side compartments)
This switch feeds the electrical motor of the Lighting Tower which will allow raising and unfolding the mast in its all.



3.7. MAST Start Control & Projectors Orientation/Direction.

a) **Mast Start Control:** It allows the control of the mast through two simple maneuver press buttons located at the waterproof and maneuvering shelter (1). Before moving the mast, it is necessary to start the electrical engine as described previously. Moreover, it is crucial to anchor and level out the tower with the extensible side legs.

The maneuver press buttons only allows safe movements of the mast. This means that you will not be allowed to spread out the mast until the mast is not completely perpendicular to the floor. Therefore you will not be allowed to pull the mast down until the every section is not already cleared. The top button controls the slope angle regarding the horizontal (0° transport position, 90° working position), and the mast raising from is vertical startign position up to 8.9 meters.

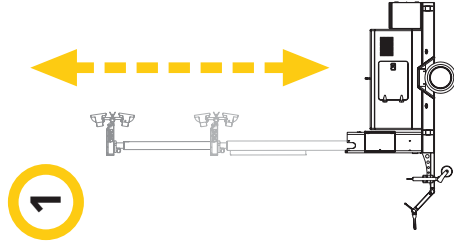



b) Projectors Direction: To give the projectors direction we must first unblock the lock screw of the mast (6b) to turn the handwheel located on the base of the mast. This orientation allows a 355° mast rotation and offers a 360° of lighting field.

3.8. Safe position when working.

For working security, we recommend that when the mast and the projectors reach the suitable position, close the hydraulic circuit key located on the base side of the mast (2) in order to avoid unexpected movements and mast falls because of a loss of load.

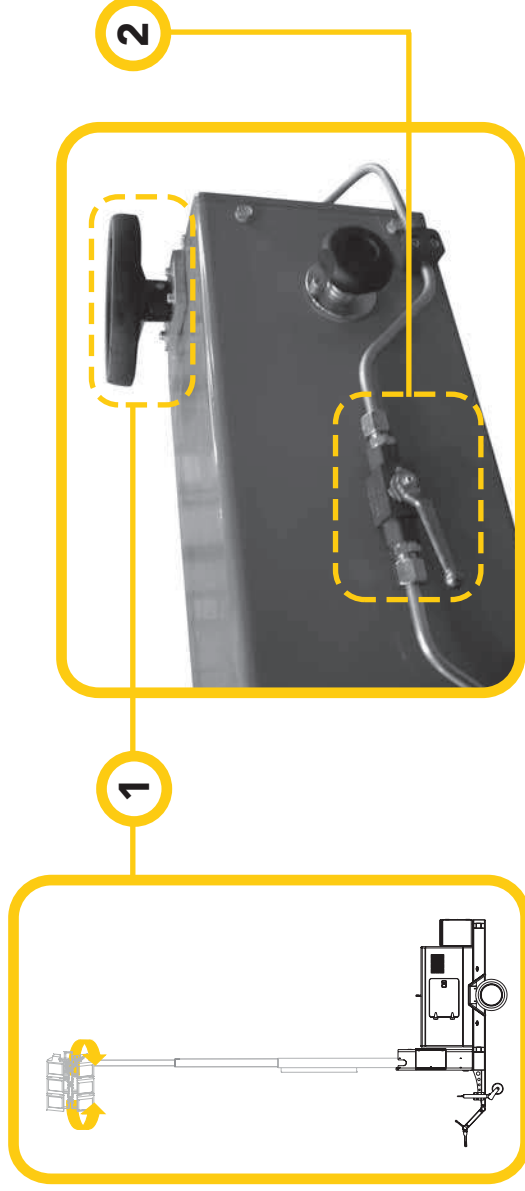



3.9. SWITCHING ON THE SPOTLIGHTS.

To switch on the spotlights, it was enough with connecting the main switch (1) located inside the tight closet of control and it maneuvers (2), next to work the three switches next to the main one that they light the focuses (1).

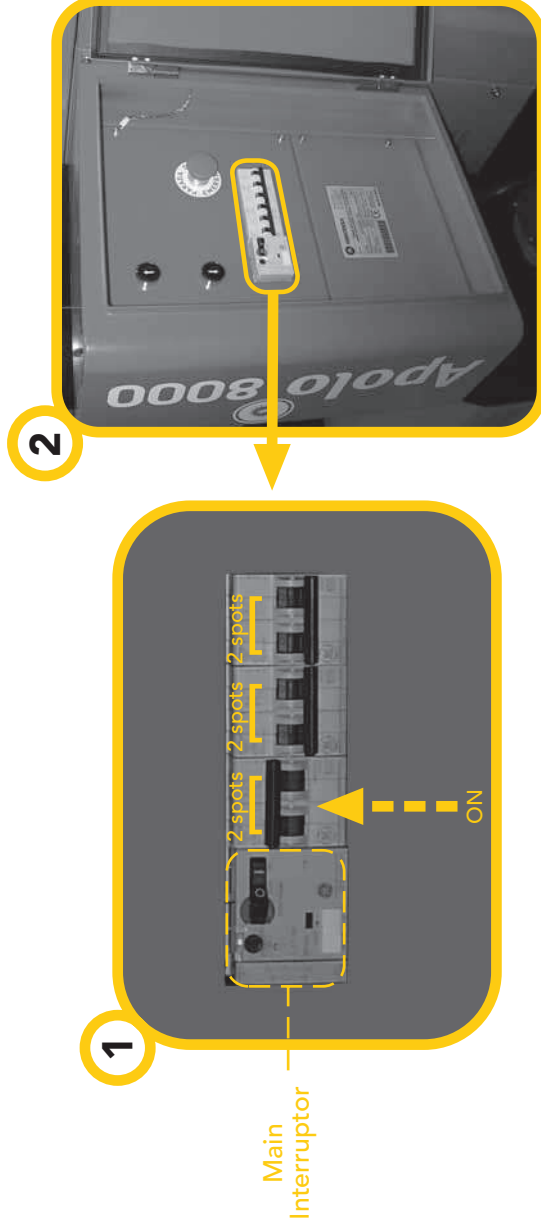



4. OPERATIONS TO CARRY OUT AFTER USE.

4.1. SWITCHING OFF THE SPOTLIGHTS.

In order to turn off the spotlights, you just have to disconnect the three switches inside the control and manoeuvring waterproof cabinet (on the right side of the main switch)

4.2. FOLDING THE MAST.

View "Apolo 9000 Control Unit" (page 14 and 15).

4.3. MAIN SWITCH DISCONNECTION.

Disconnect the main switch in the control and manoeuvring panel.

4.4. STOPPING THE GENSET.

Follow the instructions for the generating set.

4.5. DISCONNECTING THE GENSET FROM THE TOWER.

Disconnect the prolongador and keep it in the rear cabinet.

4.6. DISCONNECTING THE SPOTLIGHTS.

Disconnect the spotlights, dismount them and carefully put them in their compartments.

4.7. FOLDING OF THE TELESCOPIC SPINDLE BEARINGS.

Fold the telescopic spindle bearings and dismount the extensible legs.



5. LIGHTING TOWER MAINTENANCE.

It is necessary to check the hydraulic oil level every time the lighting tower is started, and to be cleaned more frequently when working in dusty environments and it must be refilled when necessary.

The packing of the hydraulic bottles must be checked every time the lighting tower is started.

The lubrication of the lower bolt of the hydraulic bottle has to be carried out every time we start the lighting tower.

The hoses must be checked every time start up and be replaced when necessary.

In case of blown bulbs, it is advisable to use gloves or a cloth. Don not touch the bulbs with the fingers. We must frequently clean and dry the lighting tower when operating it in a humid and dusty environment

In case of doubt contact our technical service.

6. FAILURES.

Due to the simplicity of the system, the number of failures is practically zero. However, in case of any anomaly, please contact our technical service.



7. GUARANTEE CONDITIONS

PROFESSIONAL USE (commercial) (whichever is first)

- 2.000 working hours:
- 12 months from the date of the sale
- 15 months after leaving the factory:

RESIDENTIAL USE (private) (whichever is first)

- 2.000 working hours:
- 24 months from the date of the sale:
- 27 months after leaving the factory:

The coverage of this warranty is **ONLY** applicable to the end user of the equipment recognized by Himoinsa. In the case of Generating sets, it is only applicable to those generating sets that operate together with an manual or automated control panel manufactured or/and installed by HIMOINSA. The Generating sets of 3,000 rpm have a 6 months warranty or 500 hours of continuous work, or 12 months or 1,000 hours in standby or emergency, whichever period expires first. Except when agreed, the products sold as used will have an only 3 month warranty. This Warranty benefits only the first purchaser and can not be transferred to a third-party (final purchaser) without previous authorization from/of HIMOINSA.



Company Responsibilities

In those countries where HIMOINSA may have an authorized technical assistance Network (information available at www.himoinsa.com) the warranty consists of the replacement or repair of the damaged parts once checked its due to defective material at origin, manufacturing or/and assembly, therefore , it covers both the replaced parts as well as the manpower used during the normal working hours. The customer shall be charged with transport expenses to the premises of the authorized distributor, where the repairs shall be carried out.

The warranty for the rest of the world consists of free supply on premises San Javier (Murcia # Spain), of the non usable parts due to defective material at origin, manufacturing or/and assembly. If the equipment is sent to our premises, all necessary repair tasks will be carried out free of charge.

In this case, transport both sending and return will be chargeable to the customer.

The warranty will only be given after the technical study of the defective parts. Any part sent or service carried out before the acceptance of the warranty will be billed. All replaced parts have to be returned to Himoinsa and will become of its property.

In case of defects in the motor or alternator, HIMOINSA informs that the assistance of the warranty will be provided by official technical services of the manufacturer of the alternator or motor, who will determine the scope of the warranty.

- The defect shall appear during the normal use of the product and within the warranty period. The company will supply the necessary spare parts for the repair as soon as possible but shall not be deemed responsible for any losses for not having the equipment during this period.

- All claims made based on this warranty, must be processed through your authorized seller or area distributor, who will process the claim and the scope of the warranty.

This warranty does not cover failures or defects consequence of its normal use or wear, inappropriate



use (including overload and overvoltage), negligence, accidental damages, non authorized modifications; lack of or inappropriate maintenance or connection, (inappropriate storage, transportation or installing); any kind of use of the equipment over the capacity and limits established by the manufacturer or under conditions different from those recommended; failures caused after the failure or defect had or should have been detected; batteries, lamps and fuses damages; damages **due of use** of parts not supplied or manufactured by the manufacturer. The Warranty also does not cover the rental costs of substitution equipments during repair period nor connection costs and/or connection works of the product with other equipments of the customer.

- The repaired or replaced parts have a (6) six month warranty, this will not modify the warranty of the other elements.
- Equipment or components not manufactured by the company. The company will provide a warranty equal to the one supplier, and limited to the responsibility offered by the company for its equipment.
- All claims to do with the fuel injection system or parts of it, will be referred by HIMOINSA to the manufacturer of the injection system, or to its authorized agent. The manufacturer or authorized agent's report **ON THE FAILURE** will be binding for both parties : Himoinsa and purchaser.

User Responsibilities:

The user is responsible to:

*Install and operate the product in accordance with the operation and instruction manual provided, and in its case with the assistance of qualified technical personnel and in accordance with the current regulations.

*Carry out a proper maintenance of the equipment; (including the use of appropriate fuel, oil, antifreeze, and lubricant), as well as to replace of the parts and components due to the normal use of the equipment.



*return the warranty register form properly filled in within 10 days after the start up of the product, or a month after the date of the sale, whichever is first.

*send written notification to the company or to authorized Technical assistance service in his country, of the failures of the material and justify them within seven days after the failure appeared and in any case before the expiration of the warranty, otherwise the purchaser may lose his warranty rights.

*if the repair of the defect requires the participation of other equipments not manufactured by HIMOINSA, the purchaser will be the only responsible for the works and costs resulted as well as to provide full access to the products manufactured by HIMOINSA S.L.

*accept the technical report about the existence or non existence of defects in the material or the assembly.

*the manpower costs , except for those stated in the section #Company responsibilities#, including those ones derived from the assembly and disassembly of the equipment .

*the costs and risks from transportation or shipping of the equipment, and any other costs associated with the replacement of the components.

*Any cost that may exceed the purchasing price of the product.

*Any other cost, including transport and trips, accommodation, taxes and fees, communication expenses, extra hours among others; except for those stated in section #Company responsibilities#

*payment of the total price of the machine, spare parts and related services related with the product under warranty.

The attendance of sales or technical personnel to the #start-up# or #functioning demonstration# of the equipment will not mean that the present warranty may be extended to the installation or mounting, operation expressly excluded from this warranty; it also does not imply acceptance or understanding of the correct technical installation, assembly or/and connexion of the machine carried out by the



purchaser or a third party unconnected with Himoinsa, neither of the dimensioning of the equipment purchased regarding the real power supply need of the purchaser.

The present warranty will not be applicable to the following cases:

-when the documentation (warranty, purchasing invoice, maintenance and use manual) may have been altered in any way or may be illegible.

-if the model and serial number of the generating set have been altered, erased, removed or are illegible.

HIMOINSA shall not be deemed contractually or extra contractually responsible for any material or immaterial, direct nor indirect damages; consecutive or non-consecutive to the damage on the material covered by the warranty, such as operating losses, expenses and costs due to not having the product, neither for damages to third parties or to other equipment or products.

This Warranty does not limit any other rights that as a consumer, the purchaser may have according to the current legislation. This warranty replaces any other express or implied warranty, including, without limitation any merchantability warranty of the equipment or its suitability for a particular purpose. All claims not covered by the above stipulations will not be accepted by the company.

HIMOINSA Informs the user of the obligation to follow the Maintenance and use Manual and to keep it together with the rest of the technical documentation of the equipment in observance with the safety at work regulation as well as the convenience of installing specific protections that may prevent overvoltage and overload from the main electrical line, and to protect the equipment by seeking advice of an authorized installer.